



Eurolight



In safe hands

Since 1958, people have put their trust in our trailers, just ask an owner - they're not difficult to find. As specialists in trailer design and engineering, we have continued to set the standard both in the UK and throughout much of Europe. We are an independent company with one focus: to build the best products on the market. More than 30,000 people choose our trailers each year - but we're not standing still. Our dedicated investment in new technologies and materials ensures that our products continue to exceed the expectations of our customers. We know that quality, strength, value and ease of maintenance are of vital importance to you. That's why we've made them the driving force behind everything we do.



Ifor Williams Eurolight

Our Eurolight trailer range has been introduced to provide a flatbed trailer, which is light enough to be used in many applications where the towing vehicle has restricted towing capabilities. With a gross weight up to 2000kg it complements the LT and LM trailer range where the chassis are engineered to accommodate 3500kg Gross (subject to wheel and coupling specification).

Offering a choice of eleven multi purpose trailers, the Eurolight range has been designed for versatility. With a maximum gross weight of between 750kg and 2000kg, there is sure to be a trailer in the range to suit your requirements.

Tow in style

The Eurolight range incorporates all of the high standards expected from Ifor Williams Trailers, whilst at the same time introducing aesthetic changes to produce a stylish trailer that remains in-keeping with the distinctive Ifor Williams design.

Stability when towing

Also featured in the range is the exclusive Ifor Williams beam axle and leaf spring suspension system, developed and refined for a safe and stable ride. Renowned for its durability and ease of maintenance, the Ifor Williams beam axle system contributes significantly to the low depreciation of all our trailer models.

Safety when moving

To ensure your load is restrained securely and safely whilst travelling, Eurolight trailers are offered with various load restraint options, which can give extra security for any non-standard loads.

Minimal upkeep - built to last

The galvanized steel chassis and drawbars offer unbeatable corrosion protection. All trailers are security marked and every detail is specified for top performance and a long, trouble-free life.



EX202-3615 with optional aluminium easylatch dropsides, tailboard & headboard

Ifor Williams Eurolight



The Eurolight range offers practical and stylish multi-purpose trailers that maintain the durability, robustness and ease of towing, synonymous with the Ifor Williams brand.

Ideal for both the domestic and professional user, the Eurolight offers lighter alternatives to traditional Ifor Williams Trailers and is suitable for lighter commercial vehicles and cars with lower towing weight capacities. From horse owners to landscape gardeners, the Eurolight range has been designed for various jobs for the domestic and business user.

Standard Features:

The Eurolight multi-purpose range is offered in 2 width options, 1.3m and 1.58m and 4 length options from 2.08m to 3.68m. Single and tandem axle options are available. Maximum gross weights of the Eurolight models range from 750kg to 2000kg.



EL101-2012

The Eurolight series are designed as braked trailers however we now also produce the two smallest trailers in the range (EL2012 & EL2512) as un-braked models. These offer significant value for money for an extremely versatile trailer.



EL101-2012 with optional aluminium easylatch dropsides, tailboard & headboard

Eurolight Unique Features



EL142-3615



EL142-3615 with optional steel drop sides, tailboard & headboard

Our latest trailer range offers exceptionally lightweight trailers without compromising strength or durability. The combination of engineering design and high strength materials has produced a trailer range with an excellent strength to weight ratio. Having undergone rigorous testing on our fatigue testing rig, Eurolight trailers will meet the needs of even the most demanding user.

Optional Unique Features

The Eurolight range boasts features not seen on any previous Ifor Williams multi-purpose trailers, resulting in a distinctive and stylish look:

- Aluminium dropsides with easylatch feature and integrated safety mechanism for speed and simplicity.
- Colour co-ordinated corner posts and end caps.
- Loading skids for side and rear attachment - useful for unloading awkward loads.
- Rear skid storage system.

Eurolight trailers can also be purchased with hinged steel dropsides and / or ladder rack.



To release the Aluminium dropsides simply apply slight inward pressure to the dropside then lift the latch with fingers to release. The dropsides will only release when pressed inwards prior to the latch being lifted (Lifting the latch alone will not release the dropside).

Eurolight Standard Features

Eurolight Options

It's the attention to detail of Ifor Williams trailers that makes our products so popular with owners. Just take a look at these standard features.

Chassis

The underside of the trailer features a galvanized steel chassis and drawbar, for long-lasting corrosion protection.



Floor

Resin coated on both sides, our ply platform floors feature an embossed grip pattern on the upper surface.

Beam axle & leaf spring suspension

The Ifor Williams beam axle system increases stability and reliability whilst ensuring minimum maintenance.

Spare wheel

A mounting bracket and spare wheel are fitted as standard to all Ifor Williams trailers for complete peace of mind.

Adjustable coupling height

All trailers are fitted with spacers under the coupling body. When removed, the towing height can be lowered by up to 40mm (25mm on model EL141-2515).



The lockable coupling head can be locked on or off the tow ball for additional security (Padlock not included).



Aluminium Dropsides

Removable aluminium easylatch dropsides, tailboard & headboard.



Steel Dropsides

Traditional alternative.



Aluminium Headboard

Fixed.



Steel Headboard

Removable headboard, particularly useful for transporting longer loads.



Floor Covering

Aluminium treadplate.



Perforated Steel Loading Skids

2.00m long with hook locking feature. Can be used on all trailer sides. A skid carrier may be purchased to store skids within the trailer chassis.



Lashing Rings

Recessed hinged ring providing a secure floor level fixing point.



Removable Ladder Rack

Only available with a headboard.

Eurolight Specifications

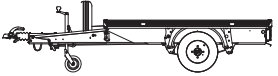
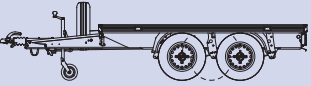
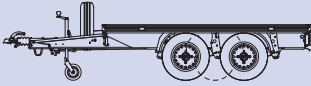
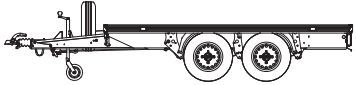
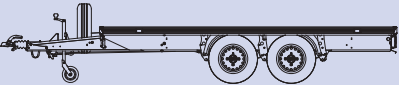
	1.30m width	1.58m width
2.08m length	EL071-2012 EL101-2012 	
2.58m length	EL071-2512 EL101-2512 EL142-2512 	EL101-2515 EL141-2515 EX202-2515 EL142-2515 
3.08m length		EX202-3015 EL142-3015 
3.68m length		EX202-3615 EL142-3615 

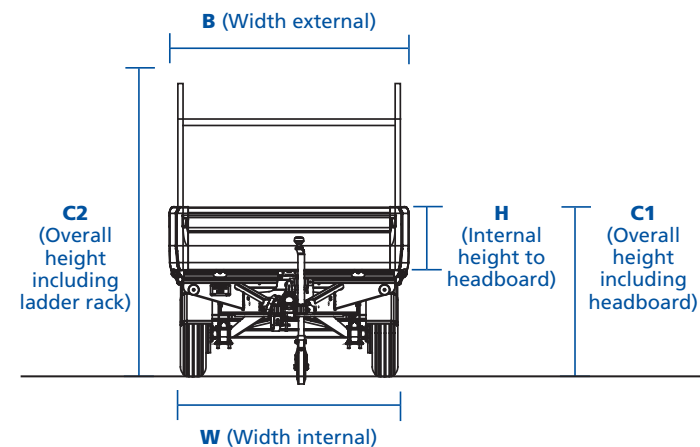
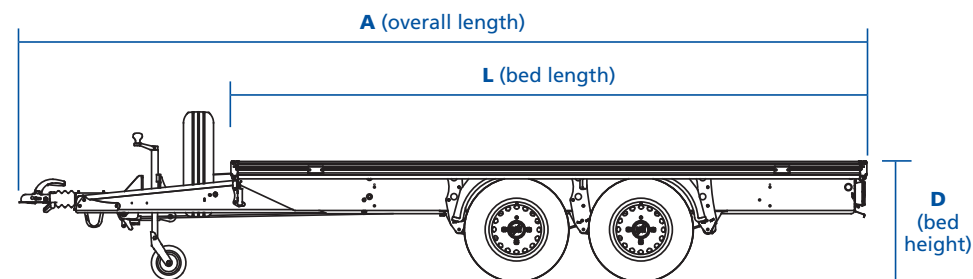

Dimensions in metres	A	B	C1	C2	D	L	W	H	Max Gross weight (kg)	*Unladen weight (kg)
Unbraked										
EL071-2012	3.29	1.39	0.99	1.84	0.66	2.08	1.30	0.35	750	195
EL071-2512	3.79	1.39	0.99	1.84	0.66	2.58	1.30	0.35	750	220
Braked										
EL101-2012	3.38	1.39	0.99	1.84	0.66	2.08	1.30	0.35	1000	225
EL101-2512	3.91	1.39	0.99	1.84	0.66	2.58	1.30	0.35	1000	250
EL142-2512	3.91	1.39	0.99	1.84	0.66	2.58	1.30	0.35	1400	320
EL101-2515	3.88	1.67	0.99	1.86	0.66	2.58	1.58	0.35	1000	290
EL141-2515	3.88	1.67	0.99	1.86	0.69	2.58	1.58	0.35	1400	300
EL142-2515	3.88	1.67	0.99	1.86	0.66	2.58	1.58	0.35	1400	350
EX202-2515	3.88	1.67	0.99	1.86	0.66	2.58	1.58	0.35	2000	360
EL142-3015	4.38	1.67	0.99	1.86	0.66	3.08	1.58	0.35	1400	370
EX202-3015	4.38	1.67	0.99	1.86	0.66	3.08	1.58	0.35	2000	380
EL142-3615	4.98	1.67	0.99	1.86	0.66	3.68	1.58	0.35	1400	400
EX202-3615	4.98	1.67	0.99	1.86	0.66	3.68	1.58	0.35	2000	405

*Unladen weight does not include optional extras

Eurolight Trailers

Trailer Fitted with Resin Coated Plywood Platform
 Aluminium Treadplate Floor Covering
 Removable Aluminium Easy-latch Dropsides, Tailboard & Headboard*
 Aluminium Headboard*
 Removable Steel Headboard, Dropsides & Tailboard*
 Removable Steel Headboard*
 Weldmesh Panelled Side Extensions* (Dropsides Required)
 Removable Ladder Rack* (Headboard Required)
 2.00m Long Steel Perforated Lockable Loading Skids & Skid Carrier* (Includes Prop Stands)
 Recessed Lashing Ring (Pair)
 Prop Stands
 Rope Hook Kit (Pair)
 Trailer Aid
 Wheel Chocks

Unbraked Trailers

	Axle	Maximum Gross Weight	Tyres	Unladen Weight	Option	Option	Option	Option	Option	Option	Option	Option	Option	Option	Option	Option	Option
EL071-2012	Single	750kg	145/80B10	195kg	Option	Option	Option	Option	Option	Option	Option	Option	Option	Option	Option	Option	Option
EL071-2512	Single	750kg	145/80B10	220kg	Option	Option	Option	Option	Option	Option	Option	Option	Option	Option	Option	Option	Option

Braked Trailers

EL101-2012	Single	1000kg	145/70R13	225kg	Option	Option	Option	Option	Option	Option	Option	Option	Option	Option	Option	Option	Option
EL101-2512	Single	1000kg	145/70R13	250kg	Option	Option	Option	Option	Option	Option	Option	Option	Option	Option	Option	Option	Option
EL101-2515	Single	1000kg	145/70R13	320kg	Option	Option	Option	Option	Option	Option	Option	Option	Option	Option	Option	Option	Option
EL142-2512	Twin	1400kg	145/70R13	290kg	Option	Option	Option	Option	Option	Option	Option	Option	Option	Option	Option	Option	Option
EL141-2515	Single	1400kg	165/R13C	300kg	Option	Option	Option	Option	Option	Option	Option	Option	Option	Option	Option	Option	Option
EL142-2515	Twin	1400kg	145/70R13	350kg	Option	Option	Option	Option	Option	Option	Option	Option	Option	Option	Option	Option	Option
EL142-3015	Twin	1400kg	145/70R13	360kg	Option	Option	Option	Option	Option	Option	Option	Option	Option	Option	Option	Option	Option
EL142-3615	Twin	1400kg	145/70R13	370kg	Option	Option	Option	Option	Option	Option	Option	Option	Option	Option	Option	Option	Option
EX202-2515	Twin	2000kg	145/70R13	380kg	Option	Option	Option	Option	Option	Option	Option	Option	Option	Option	Option	Option	Option
EX202-3015	Twin	2000kg	145/70R13	400kg	Option	Option	Option	Option	Option	Option	Option	Option	Option	Option	Option	Option	Option
EX202-3615	Twin	2000kg	145/70R13	405kg	Option	Option	Option	Option	Option	Option	Option	Option	Option	Option	Option	Option	Option

*Accessories are not factory fitted, an additional charge may be incurred if fitted by a distributor.



Ifor Williams Trailers Ltd

Cynwyd, Corwen, Denbighshire LL21 0LB UK
 Telephone +44 (0)1490 412527
 Facsimile +44 (0)1490 413216

For further information visit our comprehensive website

www.iwt.co.uk

Product design, descriptions, colours, specifications etc. correct at time of going to press. We constantly strive to improve our products, and from time to time this may result in changes to our range or to individual models. Please check that design, description, colours, specifications described in this brochure are still valid at the time of placing an order.

Our distributors have extensive product knowledge and will be pleased to offer assistance in the selection of your trailer.

© Ifor Williams Trailers Ltd 2012.
 All rights reserved.

No part of this publication may be reproduced in any form or by any means, without the prior written permission of Ifor Williams Trailers Ltd.

Dimensions and weights are given as a guide only. We reserve the right to alter specifications without notice.

Distributed throughout the UK & Europe